



Product Information
Version 1.0

ZEISS Axioscope

Your Microscope for Research and Routine in the Materials Lab



Ready to serve both Research and Routine Investigations

- › **In Brief**
- › The Advantages
- › The Applications
- › The System
- › Technology and Details
- › Service

The Axioscope upright light microscope was designed specifically to meet the most common optical imaging requirements of materials laboratories. Coded and automation features make it particularly well suited to routine tasks that place high demands on data quality and reproducibility. But Axioscope doesn't stop there. It is also capable of handling advanced optical microscopy for materials science studies.

Axioscope is a turnkey solution for metallography and materials science in research and industry – with functions for determining grain size, phases and layer thickness as well as for the classification of graphite particles. Analyze your samples with established contrast techniques. Advanced light management ensures that your samples are always optimally illuminated.

With its versatility to handle many daily tasks, Axioscope has a good chance of becoming the preferred instrument of your laboratory staff.



Simpler. More Intelligent. More Integrated.

- › In Brief
- › **The Advantages**
- › The Applications
- › The System
- › Technology and Details
- › Service

Affordable High Performance

Everyday life in the materials laboratory is characterized by both routine tasks and challenging detailed investigations. While microscopes for routine applications quickly reach their limits when high performance imaging and enhanced contrast techniques are required, high-priced research microscopes offer a range of performance that is rarely fully exploited. Axioscope – with its outstanding usability and advanced automation features – is ideal for demanding routine tasks. And, even at its attractive price, it also offers powerful capabilities commonly associated with more advanced research light microscopes.

Reliable Results

With coded components and advanced light management, Axioscope delivers trustworthy, reproducible results. The motorized Axioscope 7 gives you the ability to fully automate investigative workflows. Perform repetitive tasks with preset parameters, automatically navigate to regions of interest on the sample, or capture images with extended depth of field. Axioscope packs a lot of power and reliability into its small footprint, so it is quick to become the lab favorite.

Digital Integration

One of the best reasons to select ZEISS is their comprehensive integration platform that allows data from all ZEISS microscopes to be connected. Combine Axioscope with the ZEISS AxioCam camera portfolio and ZEISS ZEN 2 core imaging software, and Axioscope now becomes a powerful digital documentation system. From device control – to image capture, analysis and documentation – to archiving your valuable analytics, Axioscope delivers a fully digitized workflow. In addition, Axioscope can be integrated into correlative workflows via Shuttle & Find.

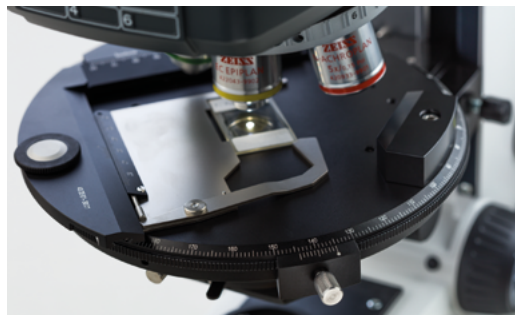

Axioscope for polarization

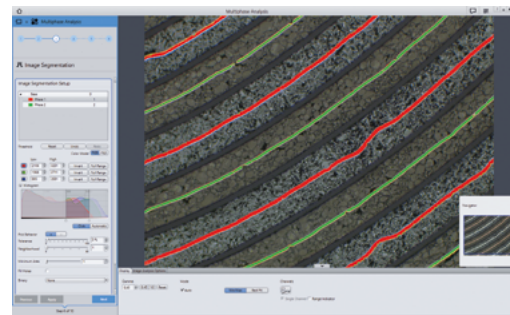

Multiphase analysis with ZEISS ZEN 2 core

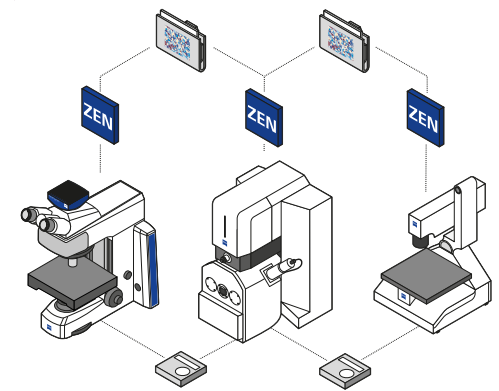

Axioscope in a connected laboratory environment

Meet Routine Microscopy Demands—without Compromise to Advanced Inspection Needs

- › In Brief
- › **The Advantages**
- › The Applications
- › The System
- › Technology and Details
- › Service

ZEISS is well known for their expertise in developing light microscope solutions. The Axioscope product family takes a well-defined position in the ZEISS materials lab solution portfolio: Axioscope is the right choice if your routine inspection tasks place high demands on usability, reproducibility and automation – and you also need advanced optical microscopy for materials analysis and metallography. Being a complete material laboratory solution, Axioscope is also the first choice from an economic point of view.



ZEISS Primotech
Compact manual microscope for material and geoscience education



ZEISS Axio Lab.A1
Manual routine microscope for the materials laboratory with ergonomic operation



ZEISS Axioscope
Encoded and motorized microscope for highly productive materials research and routine



ZEISS Axio Imager
High-end microscope system for advanced materials research

A Turnkey Metallography Solution

- › In Brief
- › **The Advantages**
- › The Applications
- › The System
- › Technology and Details
- › Service

Axioscope is performance-ready, with all features working in concert to deliver a complete metallography solution for the materials laboratory: cameras as the most important interface for digitizing your sample data, lenses with application-specific properties, and an imaging software specially developed for materials research and metallography.

ZEN 2 core: Imaging Software with Integrated Materials Modules

ZEN 2 core is your command center for automated imaging and analysis functions. Modules for the determination of grain sizes, phases and layer thicknesses, as well as for the classification of graphite particles, enable ZEN 2 core to provide all meaningful metallographic applications under a uniform user interface.

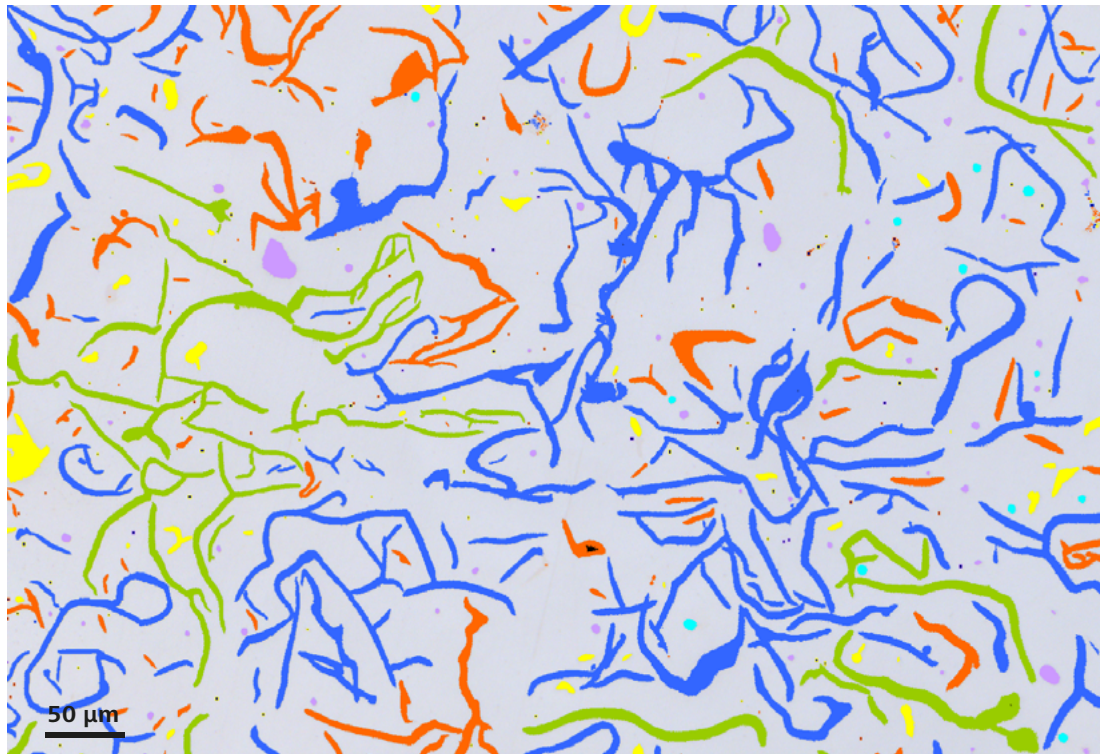

Cast iron analysis with ZEISS ZEN 2 core



ZEISS objective lenses

Select the objectives that fit your application, imaging performance or cost requirements and imaging performance.



ZEISS AxioCam cameras

Choose from a wide range of microscope cameras to get the resolution, color fidelity and processing speed you need.

Easy to Use for Powerful Workflow Efficiencies

- › In Brief
- › **The Advantages**
- › The Applications
- › The System
- › Technology and Details
- › Service

Ergonomic Operating Concept

Axioscope is designed to make everyday operations as comfortable and safe as possible. Important controls – like focus drive, stage drive, light manager and image capture – are arranged on both sides such that they can be operated without overworking either hand.

Easy Image Acquisition

Using the snap button, digital image acquisition is easy. Simply press this ergonomically located button, and you can acquire images while maintaining control over position, magnification or contrast. In this way, the microscopic examination can be fully documented, while you always keep the sample in view.



Axioscope controls

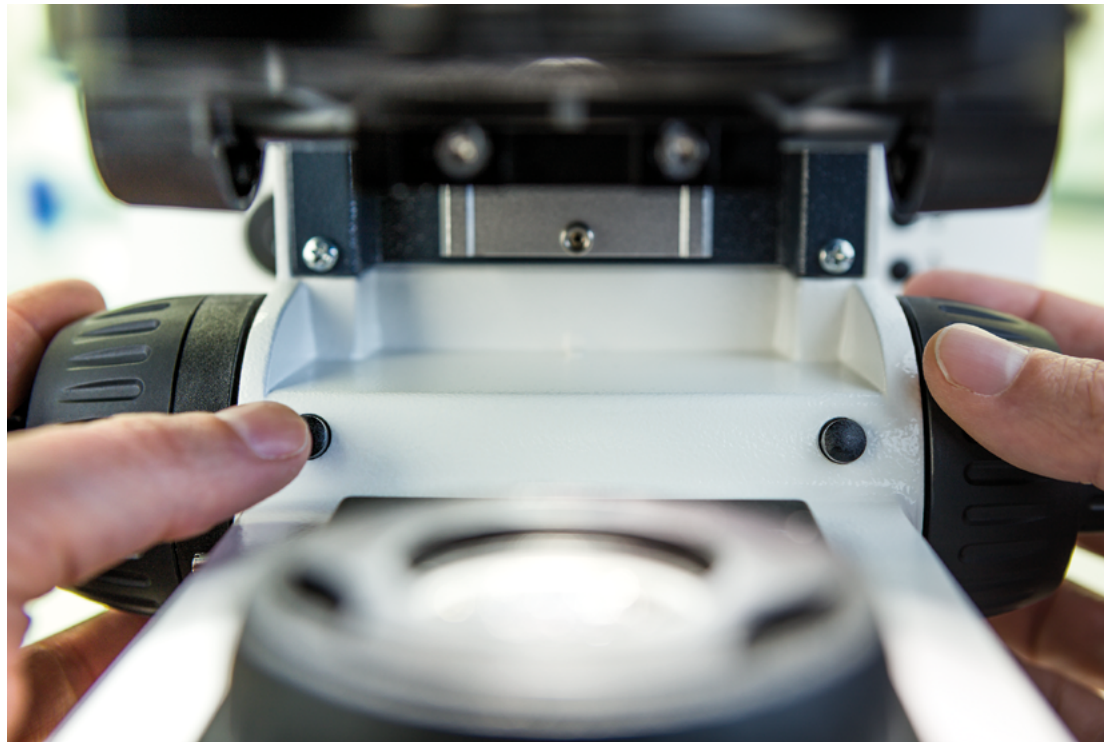

*Axioscope 5: Snap button for image acquisition on both sides
Axioscope 7: Snap button (right) and stage control button (left)*

Perfect Control of All Stage Axes

The innovative operating concept of Axioscope 7, the motorized product version, gives you full control over all stage movement, without having to take your hands off the microscope or relying on external controllers. With the simple press of a button, you can switch the focus drives between Z-axis control and XY stage control. With the XY control activated, you can move the stage along the X axis with the right focus drive and along the Y axis with the left focus drive.

Coded Components Assure Reliable and Reproducible Results

- › In Brief
- › **The Advantages**
- › The Applications
- › The System
- › Technology and Details
- › Service

Full Confidence in Your Data

The coded components of the microscope not only make your work easier and more comfortable, but also ensure that erroneous operation and the associated falsification of the examination results can be largely ruled out.

Modern Light Management

The system detects changes to objectives or contrast techniques, then adjusts dependent parameters – such as light intensity and scaling – automatically. This allows multi-faceted routine workflows to be processed more quickly and easily. Using process parameters that you or others have stored, anyone can reproduce an exact workflow at any time and achieve comparable results, independent of individual users' operating habits or preferences.



Light manager control

10× (Brightfield)

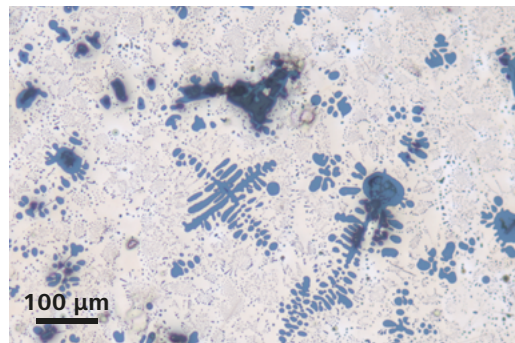

50× (Brightfield)

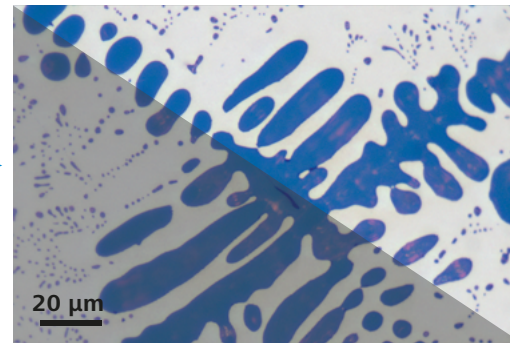

Automatic adjustment of the light intensity after changing the objective (upper right)

50× (Darkfield)

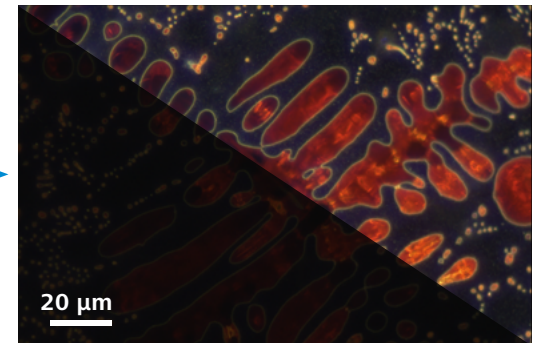

Automatic adjustment of the light intensity after changing the objective and contrasting technique (upper right)

Motorization Facilitates Automation

- › In Brief
- › **The Advantages**
- › The Applications
- › The System
- › Technology and Details
- › Service

Motorization of the X, Y and Z axes

Axioscope 7, the motorized model in the Axioscope product family, enables you to automate much of your work process. Benefit from higher productivity, repeatable processes based on predefined parameters, and better comparability of results. Full motorization of the X, Y, and Z motion axes opens many opportunities for advanced imaging:

Extended Depth of Field:

- Automatically acquire multiple images at different focus positions (Z-stack) and combine them to create an image with enhanced depth of field.

Panorama Images:

- Create composite images of larger sample areas in just a few clicks.

Tiles & Positions:

- Record exact, highly resolved images of multiple field of views by automatically scanning predefined areas.

Correlative Microscopy:

- Examine samples with different light and electron microscopes. Relocate regions of interest automatically using the Shuttle & Find module of ZEN 2 core.

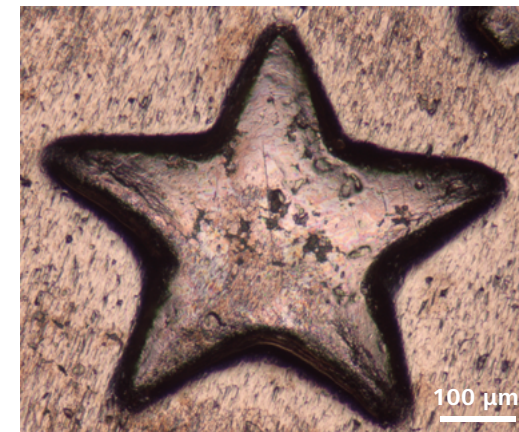

Metal bump, imaged with Extended Depth of Field

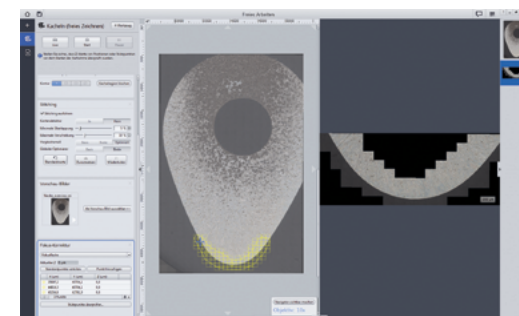

Tiles & Positions: Overview image of a cam with predefined area (left);. Acquired image of the predefined area (right)

Connect and Correlate

- › In Brief
- › **The Advantages**
- › The Applications
- › The System
- › Technology and Details
- › Service

The Connected Laboratory

ZEN 2 core helps you to make your laboratory even more productive. With workflow solutions that connect data from different microscopes, ZEN 2 core delivers more meaningful information. And thanks to its archive and database connectivity features, you keep your valuable data together across instruments, laboratories, and locations.

Shuttle & Find

Shuttle & Find is the ZEISS correlative microscopy interface, designed specifically for use in materials analysis and industrial QA.

Shuttle & Find allows you to:

- Transfer samples between ZEISS light and electron microscope systems faster than ever
- Relocate regions of interest automatically
- Improve efficiency and throughput
- Collect the maximum relevant information
- Make well informed material decisions

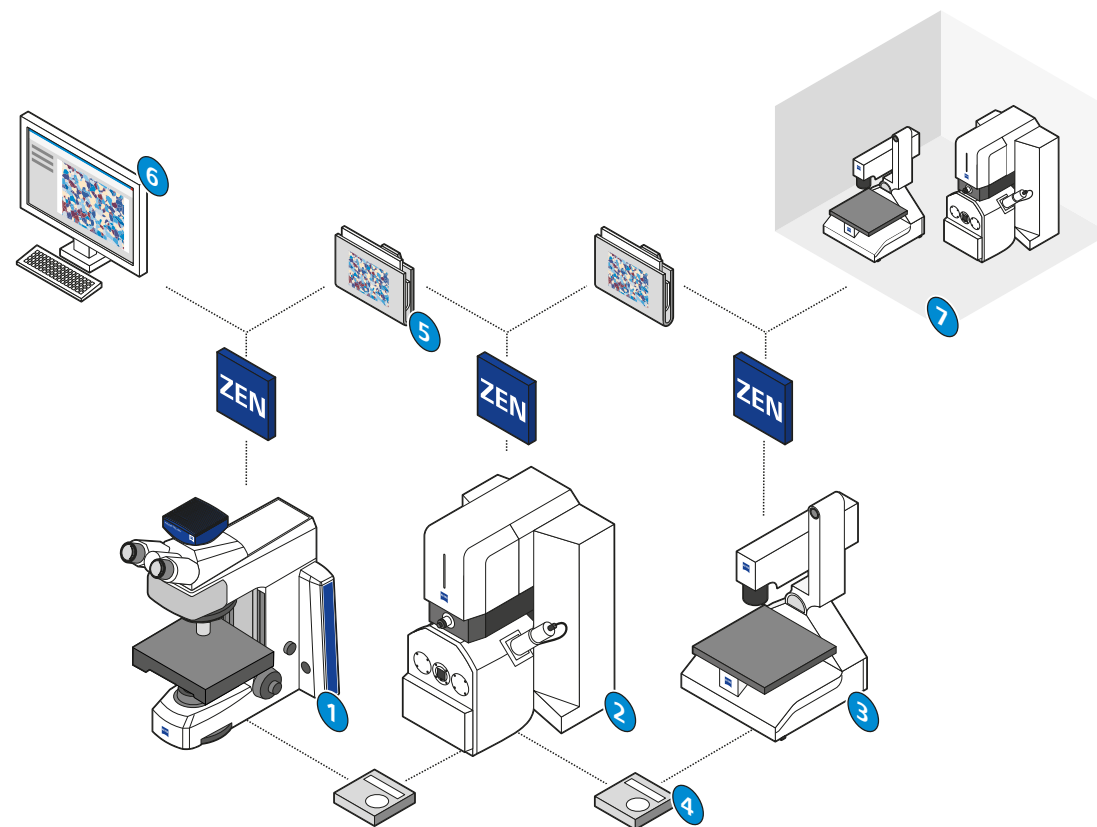

Connected laboratory environment with Axioscope (1), ZEISS EVO electron microscope (2) and Smartzoom 5 digital microscope (3). In a multi-modal workflow, the sample to be examined is passed on from microscope to microscope (4). ZEN 2 core (5) ensures consistent data exchange between all involved devices, off-line analysis workstations (6), and remote laboratories (7).

ZEISS Axioscope at Work: Contrast Techniques

- › In Brief
- › The Advantages
- › **The Applications**
- › The System
- › Technology and Details
- › Service

Versatile Options: The Contrast Techniques

A multitude of contrast options have been implemented in the Axioscope in order to meet the special requirements of materials microscopy. Such variety of reflected- and transmitted-light techniques is unusual in this performance class.

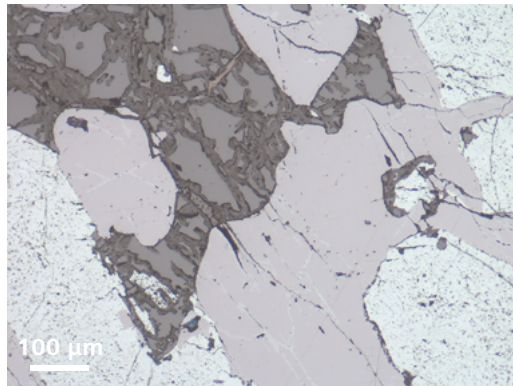

Brightfield – contrast method to identify size and shape of different phases

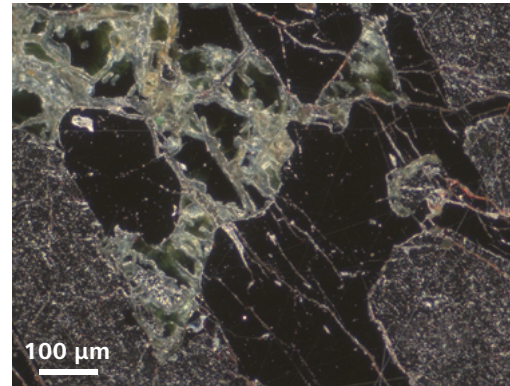

Darkfield – contrast method to enhance the visibility of phase boundaries

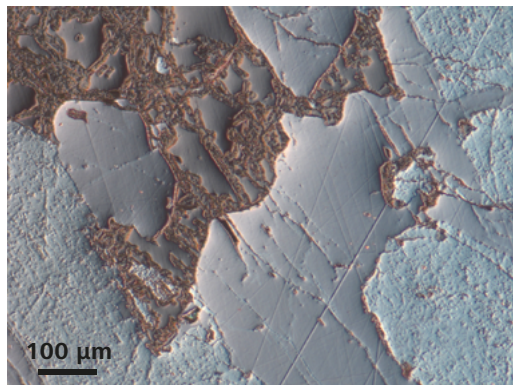

C-DIC (Circular Differential Interference Contrast) – relief-like appearance of the surface shows structures like scratches

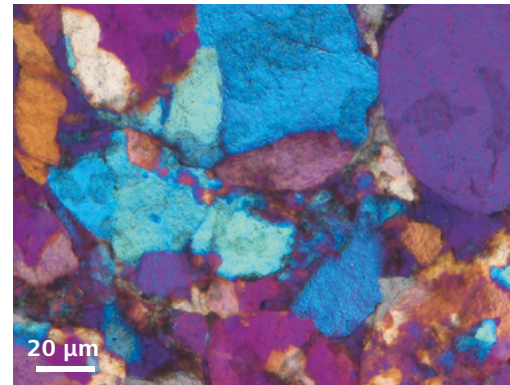

Polarization Contrast – the colors are connected with chrystallo-graphic orientation of the different phases

Reflected light:

- Brightfield
- Darkfield
- Polarization
- DIC
- C-DIC
- Fluorescence

Transmitted light:

- Brightfield
- Polarization
- Darkfield
- DIC
- PlasDIC
- Phase contrast

ZEISS Axioscope at Work: Metallography

- › In Brief
- › The Advantages
- › **The Applications**
- › The System
- › Technology and Details
- › Service

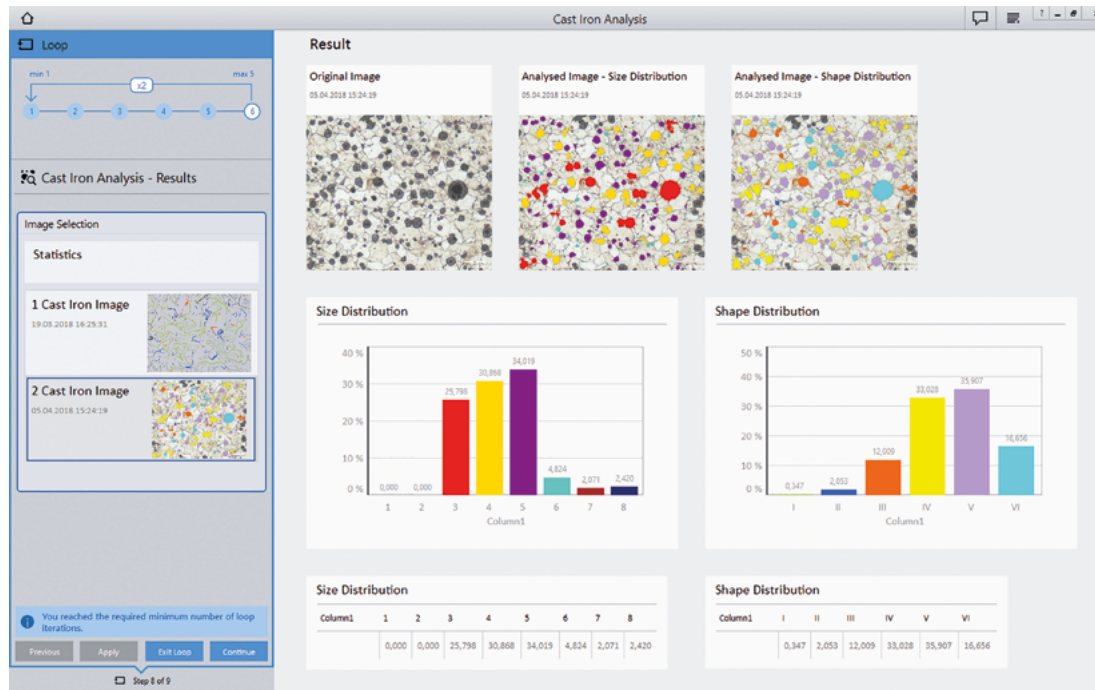

Cast Iron Analysis – Size and Shape Distribution

Typical tasks and applications

- Imaging and analysis of microstructure of metal materials
- Quantitative microstructure analysis
- Evaluation according to international standards
- Grain size analysis
- Multiphase analysis

Get these benefits from ZEISS Axioscope

- Reveal microstructural information using different contrast methods.
- Use brightfield contrast to get information about the overall number, size and shape of features within a material.
- Enhance grain boundaries and particle edges with darkfield contrast to reveal sharper features and clearer definition of interfaces.
- With Circular Differential Interference Contrast (C-DIC) your sample surface appears as a 3D relief. You can easily detect polishing marks.
- Encoded components assure that you always get the right light intensity and scaling to provide reproducible results.

ZEISS Axioscope at Work: Metallography

- › In Brief
- › The Advantages
- › **The Applications**
- › The System
- › Technology and Details
- › Service

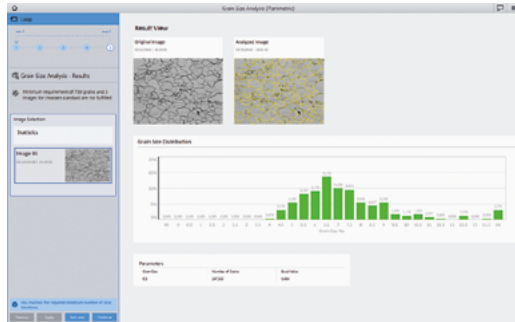

Grain Size Analysis – Planimetric Method

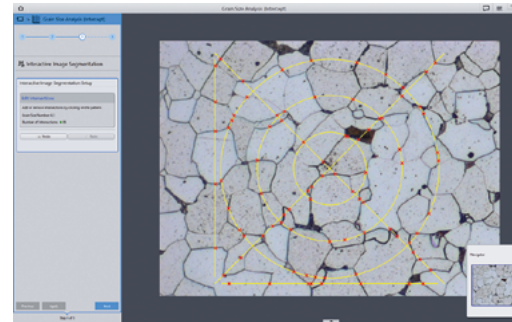

Grains Size Analysis – Intercept Method

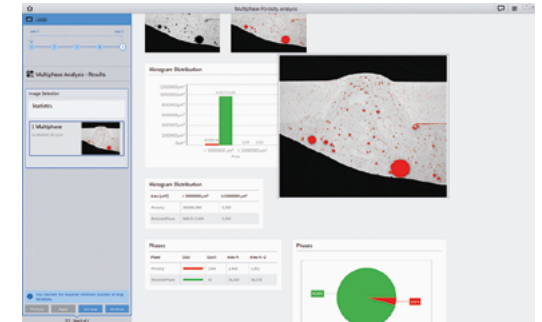

Porosity Analysis with Multi-Phase Module

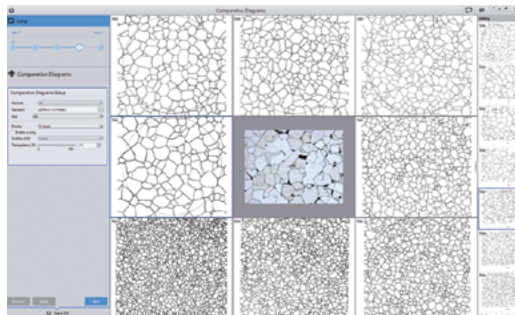

Comparative Diagrams – sample comparison with wall charts

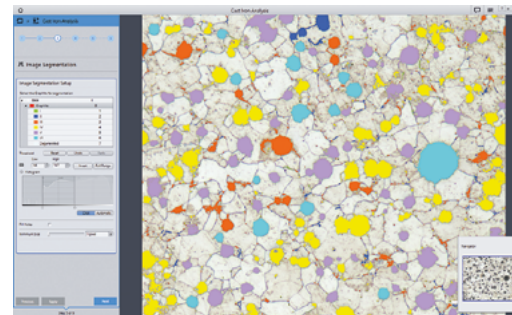

Cast Iron Analysis – Segmentation of graphite particles

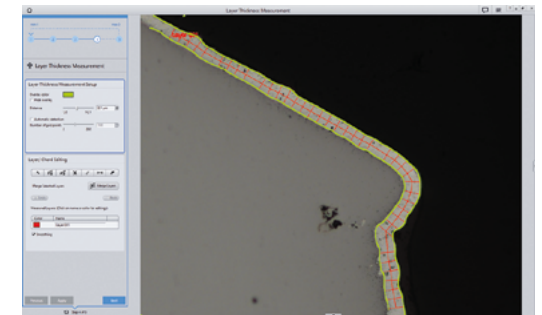

Layer Thickness Measurement

The ZEISS Axioscope Family

- › In Brief
- › The Advantages
- › The Applications
- › **The System**
- › Technology and Details
- › Service

The Axioscope product family offers instrument variants for routine tasks and advanced research applications. Each configuration has been optimized for specific applications with all relevant contrast techniques available to support your microscopic inquiry. Attention to ergonomics assures that all users benefit from comfortable and easy operation.

Axioscope 5

Manual microscope with coded components for reproducible and reliable results in the analysis of material cuts, thin sections, and fracture surfaces

Axioscope 5 for Polarization

Manual microscope with coded components for reproducible and reliable results in typical applications for polarization microscopy: geology, mineralogy and metallography

Axioscope 7

Microscope with coded and motorized components for material microscopy tasks that require advanced imaging capabilities and workflow automation



ZEISS Axioscope 5



ZEISS Axioscope 5 for Polarization



ZEISS Axioscope 7

The ZEISS Axioscope Family

- › In Brief
- › The Advantages
- › The Applications
- › **The System**
- › Technology and Details
- › Service



ZEISS Axioscope Vario

Axioscope Vario

The most flexible material microscope in the Axioscope family, Axioscope Vario is the ideal solution for more unusual specimens. Axioscope Vario is designed for reflected-light and fluorescence applications, with extended specimen space that accommodates large objects up to 380 mm. An important operating advantage is the crank device at the top of the stand's column. This crank allows users to continuously adjust the vertical position of the microscope body by hand, without need for special tools. The metal base plate further reduces vibration to provide the stability required for all materials investigations.

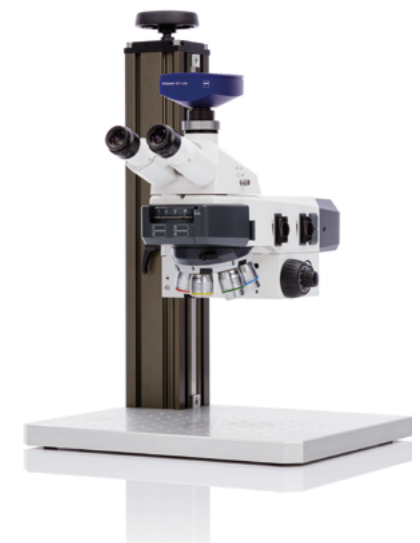

Your Flexible Choice of Components

- › In Brief
- › The Advantages
- › The Applications
- › **The System**
- › Technology and Details
- › Service



Microscope

- Axioscope 5
- Axioscope 5 for Polarization
- Axioscope 7
- Axioscope Vario

Objectives

- EC-EPIPLAN
- EC-Epiplan-NEOFLUAR
- EC-Epiplan-APOCHROMAT

Illumination

- LED 10W
- HAL 100W (Halogen)

Cameras

- Axiocam 105
- Axiocam 305
- Axiocam 503
- Axiocam 506
- Axiocam 512

Software

- ZEN 2 core
- Matscope

System Overview

- › In Brief
- › The Advantages
- › The Applications
- › The System
- › Technology and Details
- › Service

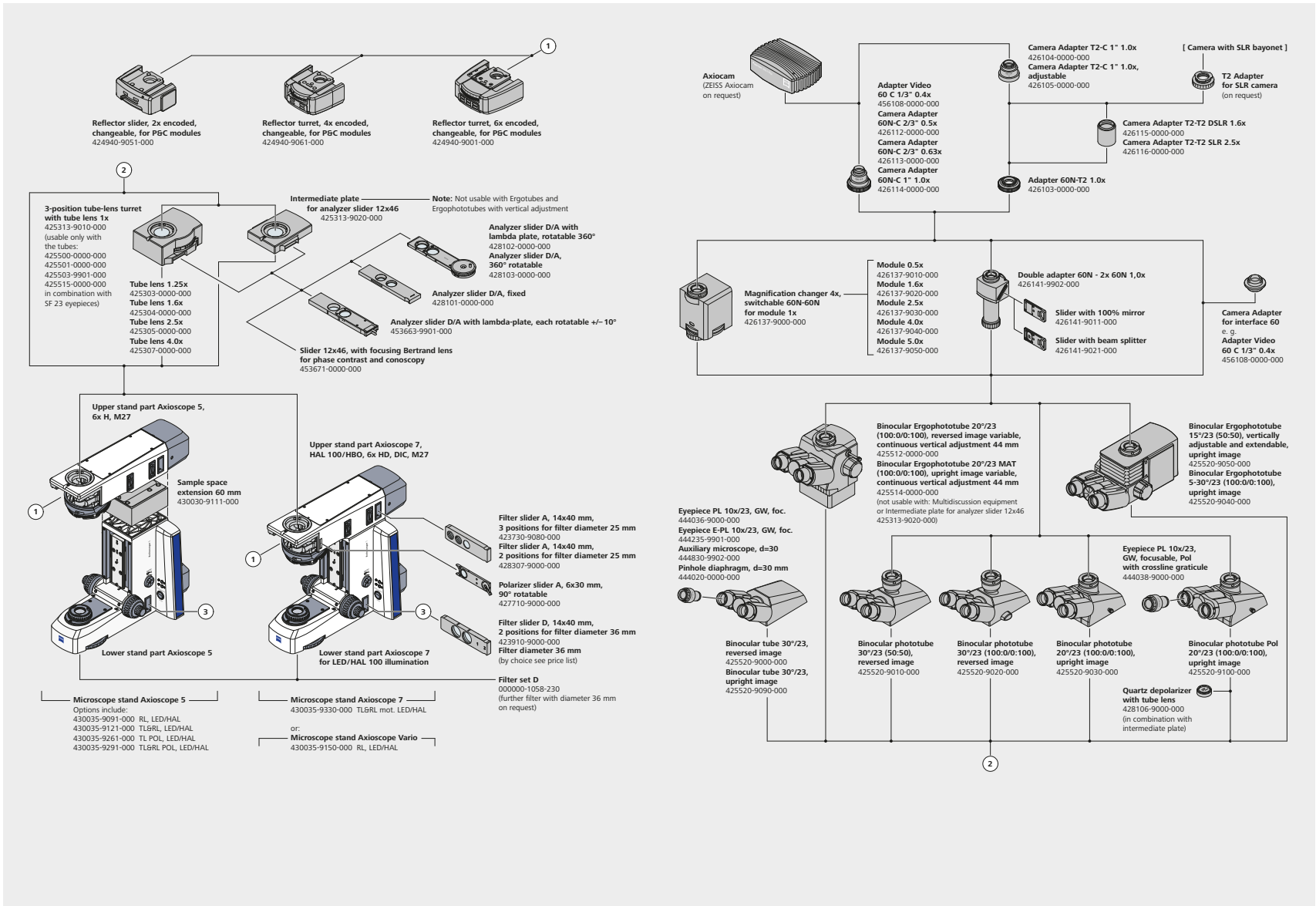

System Overview

- › In Brief
- › The Advantages
- › The Applications
- › **The System**
- › Technology and Details
- › Service

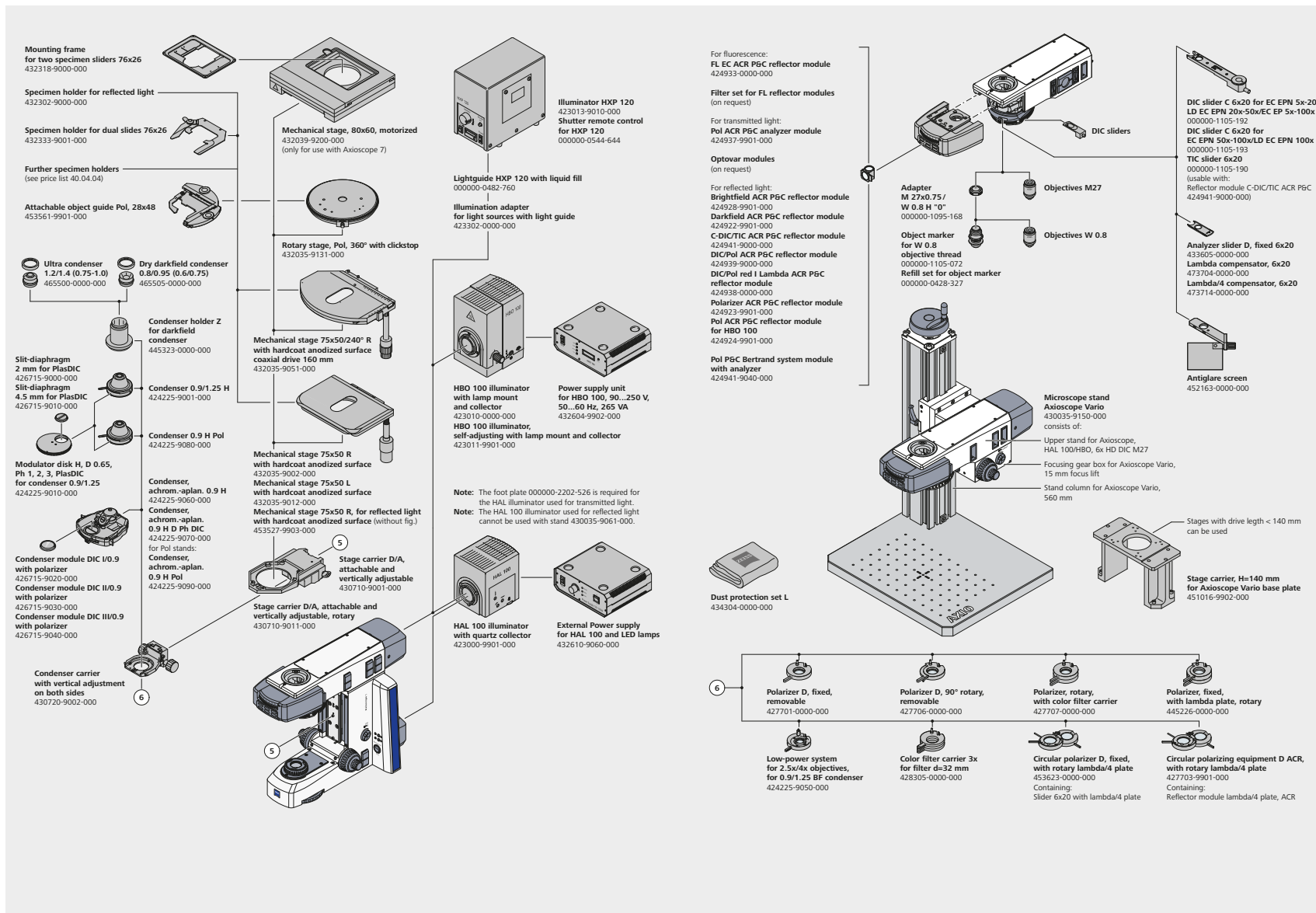

Product Dimensions: Axioscope

- › In Brief
- › The Advantages
- › The Applications
- › **The System**
- › Technology and Details
- › Service

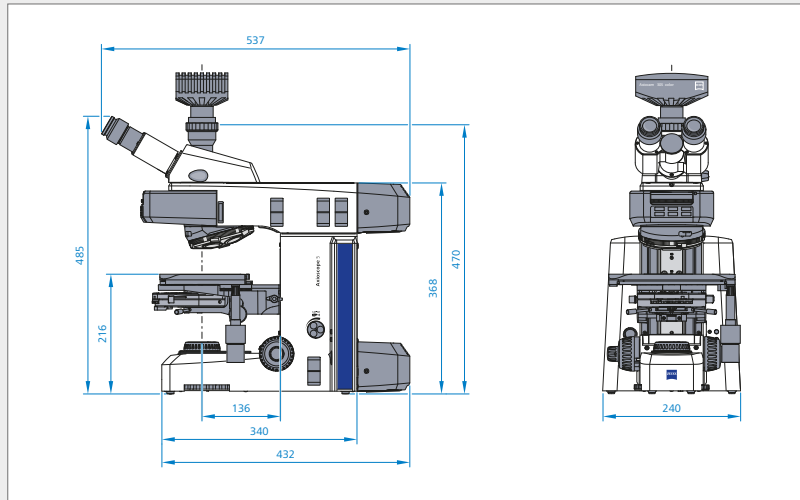

Axioscope 5

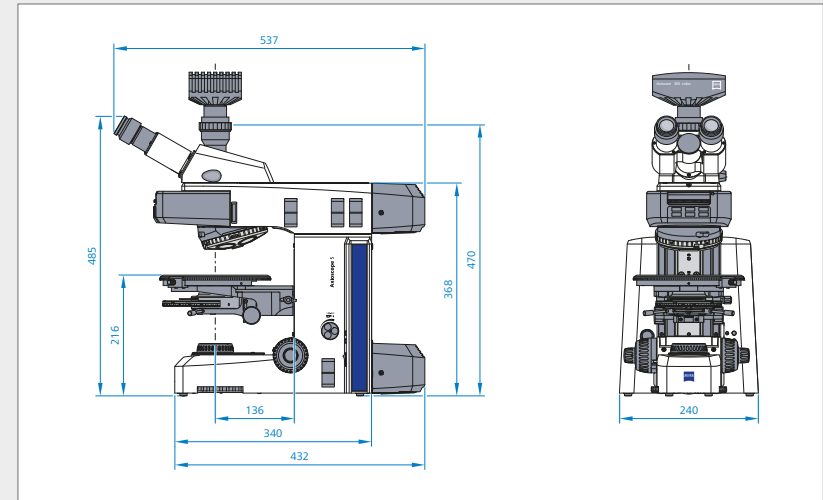

Axioscope 5 Polarization

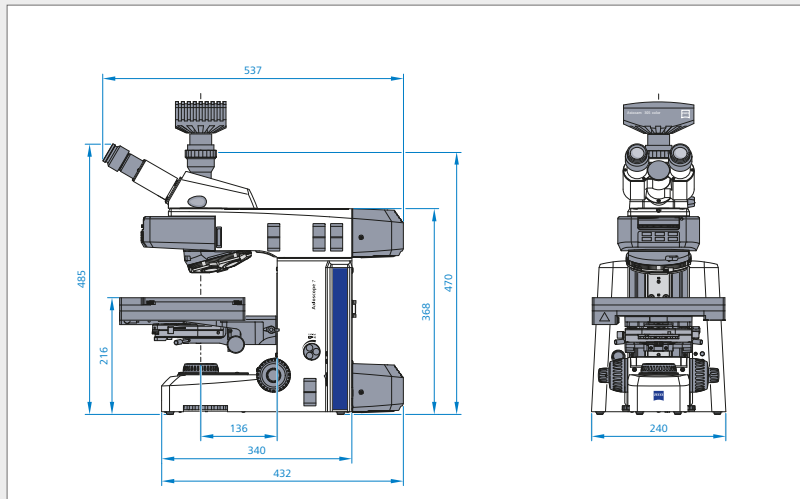

Axioscope 7

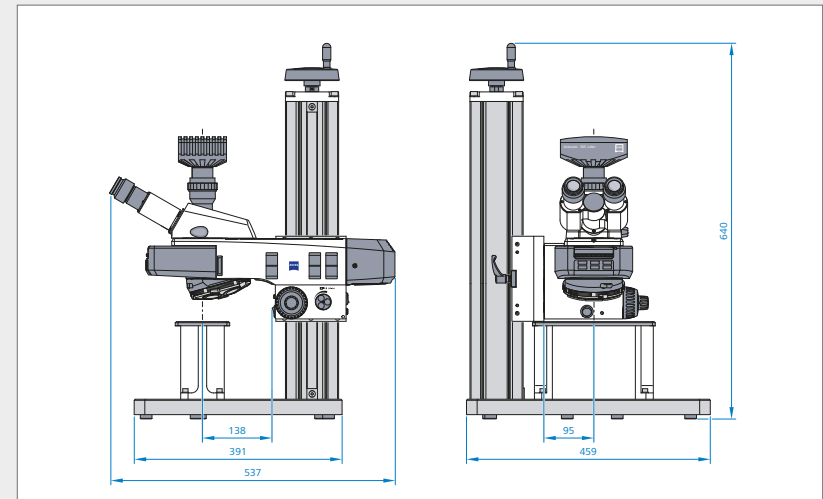

Axioscope Vario

Technical Specifications

- › In Brief
- › The Advantages
- › The Applications
- › The System
- › **Technology and Details**
- › Service

Dimensions (length x width x height)

Microscope stand for Axioscope 5/7	approx. 293.5 mm x 240 mm x 367.5 mm
Microscope stand for Axioscope Vario	approx. 429 mm x 458.5 mm x 700 mm

Weight

Microscope stand for Axioscope 5/7 (depending on stand configurations and accessories)	approx. 14 to 20 kg
Microscope stand for Axioscope Vario	approx. 32 kg

Ambient conditions

Shipping (in packaging):

Permissible ambient temperature	-40 to +70 °C
Permissible humidity (no condensation)	max. 75% at 35 °C

Storage:

Permissible ambient temperature	+10 to +40 °C
Permissible humidity (no condensation)	max. 75% at 35 °C

Operation:

Permissible ambient temperature	+10 to +40 °C
Permissible relative humidity (no condensation)	max. 75% at 35 °C
Highest permitted altitude of use	max. 2000 m
Air pressure	800 hPa to 1060 hPa
Degree of pollution	2

Technical Specifications

- › In Brief
- › The Advantages
- › The Applications
- › The System
- › **Technology and Details**
- › Service

Operational specifications	
Operational area	Closed rooms
Protective class	I
Protection type	IP 20
Electrical safety	in accordance with DIN EN 61010-1 (IEC 61010-1) in conjunction with CSA and UL regulations
Overvoltage category	II
RFI suppression	conforming to EN 55011 Class B
Noise immunity	conforming to DIN EN 61326/A1
Mains voltage for the Axioscope 5/7 with internal power supply unit	100 to 240 V
Mains voltage for the Axioscope Vario with external power supply unit	100 to 240 V
Mains frequency	50/60 Hz
Power consumption of the Axioscope 5 with internal power supply unit	60 VA
Power consumption of the Axioscope 7 with internal power supply unit	100 VA
Power consumption of the Axioscope Vario with external power supply unit	30 VA
HBO 100 W power supply unit	
Range of application	indoor
Protection class	I
Protection type	IP 20
Mains voltage	100 VAC ... 240 VAC No voltage adjustment required
Mains frequency	50 ... 60 Hz
Power consumption with HBO 103 in operation	155 VA

Technical Specifications

- › In Brief
- › The Advantages
- › The Applications
- › The System
- › **Technology and Details**
- › Service

Fuses in accordance with IEC 127

Axioscope 5/7 microscope stand for LED illumination in transmitted light:	2 T 3.15 A/H, 5x20 mm
Axioscope 5/7 microscope stand for HAL 50 illumination in transmitted light:	2 T 3.15 A/H, 5x20 mm
HBO 100 W power supply unit	T 2.0 A/H, 5x20 mm
12 V DC 100 W external power supply unit	2 T 5.0 A/H, 5x20 mm

Light sources

LED illumination transmitted light/reflected light

Power consumption	max. 10 W
Adjustment of light source	continuous approx. 10 to 800 mA

Halogen lamp	12 V/50 W
--------------	-----------

Adjustment of light source	infinitely variable from approx. 3 to 12 V
----------------------------	--

Halogen lamp	12 V/100 W
--------------	------------

Adjustment of light source	infinitely variable from approx. 3 to 12 V
----------------------------	--

Mercury vapor short arc lamp	HBO 103 W/2
------------------------------	-------------

Power consumption for HBO 103 W/2	100 W
-----------------------------------	-------

Axioscope 5/7/Vario

Stand with manual/motorized stage focusing

Coarse drive	approx. 4 mm/rotation
--------------	-----------------------

Fine drive	approx. 0.4 mm/rotation; approx. 4 µm scale intervals
------------	---

Lifting range	approx. 25 mm
---------------	---------------

Height stop	mechanically variable
-------------	-----------------------

Condenser 0.9/1.25 H with optional modulator disk	for brightfield, darkfield and phase contrast 1, 2, 3 or PlasDIC
---	--

Manual objective change	via nosepiece, 6x H, M27 encoded
-------------------------	----------------------------------

Manual reflector module change	via reflector slider 2x encoded, reflector turret 4x encoded or 6x encoded
--------------------------------	--

Count on Service in the True Sense of the Word

- › In Brief
- › The Advantages
- › The Applications
- › The System
- › Technology and Details
- › **Service**

Because the ZEISS microscope system is one of your most important tools, we make sure it is always ready to perform. What's more, we'll see to it that you are employing all the options that get the best from your microscope. You can choose from a range of service products, each delivered by highly qualified ZEISS specialists who will support you long beyond the purchase of your system. Our aim is to enable you to experience those special moments that inspire your work.

Repair. Maintain. Optimize.

Attain maximum uptime with your microscope. A ZEISS Protect Service Agreement lets you budget for operating costs, all the while reducing costly downtime and achieving the best results through the improved performance of your system. Choose from service agreements designed to give you a range of options and control levels. We'll work with you to select the service program that addresses your system needs and usage requirements, in line with your organization's standard practices.

Our service on-demand also brings you distinct advantages. ZEISS service staff will analyze issues at hand and resolve them – whether using remote maintenance software or working on site.

Enhance Your Microscope System.

Your ZEISS microscope system is designed for a variety of updates: open interfaces allow you to maintain a high technological level at all times. As a result you'll work more efficiently now, while extending the productive lifetime of your microscope as new update possibilities come on stream.



Profit from the optimized performance of your microscope system with services from ZEISS – now and for years to come.

>> www.zeiss.com/microservice



Carl Zeiss Microscopy GmbH
07745 Jena, Germany
microscopy@zeiss.com
www.zeiss.com/axioscopemat

